

GCT-IND 7L/s

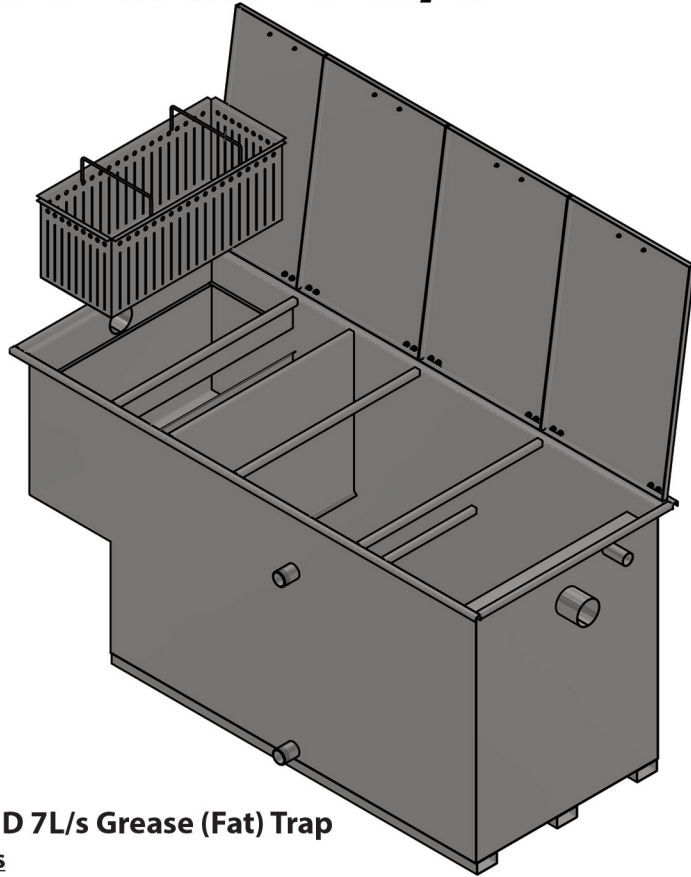

GCT-IND 7L/s Grease (Fat) Trap

Features

- Manufactured from 304 stainless steel (316 on special order)
- Separated sludge trap & grease trap
- Slotted basket strainer for easy removal of solids
- Fully accessible outlet pipe via inspection cover
- Compatible with standard plumbing fittings
- Four (4) easily accessible hinged covers
- Fat take-off port for grease extraction
- Drainage port for emptying the grease trap
- Chamber vent pipe to prevent airlocking
- Smooth surfaces to prevent bacteria build up and promote ease of cleaning
- Suitable for above ground installations
- SANS 10252-2 compliant

Flow Rate: 7L/sec

Max Grease Capacity: ≈ 300KG

Net Weight: 235KG

General Applications:

Hotels, hospitals, food processing plants, commercial & industrial kitchens etc

