

GCT 141H Eurostyle™

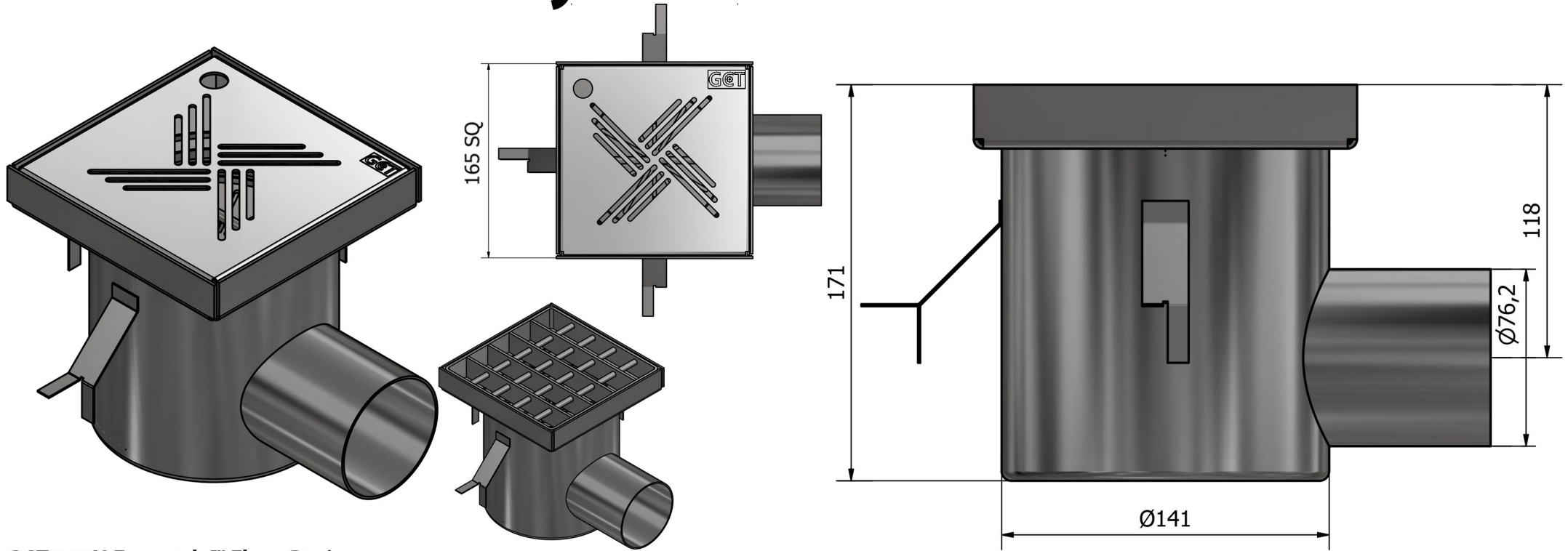

GCT 141H Eurostyle™ Floor Drain

Features

- Manufactured from 304 stainless steel (316 on special order)
- Removable tamper-proof water seal assembly
- Compatible with standard plumbing fittings
- SANS 51253-1/ EN 1253-1 compliant 50mm water seal
- Compatible with tiled and epoxy floors
- Hygienic design as per EN 1672
- Fully pickled/ passivated body
- Horizontal (side) outlet pipe
- Removable silt basket
- Alternative lid & edge option

Flow Rate: 1.2L/sec

Load Class: K3 (3kN) [Standard]
 L15 [Special Order]
 R50 [Special Order]
 M125 [Special Order]
 N250 [Special Order]

Net Weight: 3KG

General Applications:

Food processing plants, commercial & industrial kitchens etc

